

Cat.08

**SLOKY**<sup>®</sup>

Smart Torque  
Everywhere Possible



# Torque Tool & Screwdriver

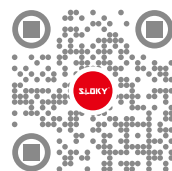

## Application Unlimited

SLOKY® torque tool can be customized to a desired torque value or different shapes to assist users in attaining more accurate fastening. Easy customization, always secure your product quality!



## Tool Holder & Cutting Tool

The SLOKY® torque screwdriver allows any technician to deliver the correct torque to the screws which can secure repeatable and accurate clamping. Properly clamping the fixture directly influence the accuracy, quality and production.



Torque range : 0.1~18.0 Nm

# Smart Torque Everywhere Possible

### Features :

- No over and under tighten
- "Click" sound
- Precise torque accuracy
- Color identity
- Patented

### Specification :

- Torque range: 0.1~18.0 Nm
- Connecting and driving portion can be designed by request.



## Electronic Devices

Choosing the accurate preset torque and reliable tool for assembly line can optimize productivity and quality as it can reduce defected products and minimize production downtime.



Torque range : 0.1~6.0 Nm

## Construction

The SLOKY® torque screwdriver allows any user to deliver the correct torque with confidence in various fastening applications regardless of operator skill levels. Easy & Simple!



Torque range : 0.6 ~ 18.0 Nm

## Micro-Technology

The specification of the micro-technology torque range has been carefully created to satisfy your needs. It optimizes assembly of small torque applications : watches, glasses, jewelry, and other tiny products.

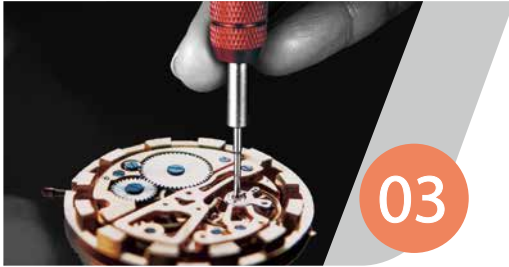

03

Torque range : 0.8 cNm~6.0 Nm

## Medical

Medical technology demands exceptional quality everytime whether you use bone screws, implants, prostheses or other medical devices. Precise torque control like SLOKY® torque tool plays a crucial foundation.



04

Torque range : 0.1~6.0 Nm



No Over Tighten,  
torque remains the same  
value once reach the  
demand torque.  
No increase, No drop.



A "Click" sound when the  
demand torque is reached.



Reversible system.  
30% higher torque for  
loosening.



Fasten and loosen  
by same tool, no need  
to change.

## Sports

More and more modern sports equipment adopts lightweight components which require specific tension and tightening for each screw on the equipment, and doesn't come loose when you are playing.



07

Torque range : 0.1~18.0 Nm

## Fastener & Hardware

Only the exact torque guarantees a secure fastening as well as a quick and easy loosening. SLOKY® torque tool has a reversible system which can use the same screwdriver for tightening and loosening the screws.

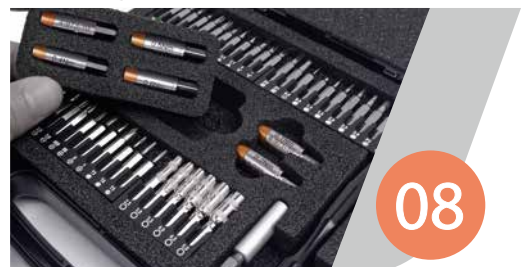

08

Torque range : 0.1~18.0 Nm



Select Nm

S

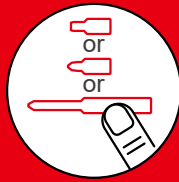

Length of bit

L



Ok to go

O



Keep tightening

K



Yes it's done

Y



# About Us

“SLOKY®” comes from the meaning of “SOLO KEY” in Taiwanese dialogue.

It is defined from the position of patented adapter in torque screwdriver system as a solo performer.

Patented adapter plays as a solo performer, with a unique feature to build whole product system.

The torque's value is setting on the adapter; complied with various bits and handles become torque screwdrivers for tighten or loosen the screw.

Sloky torque screwdriver, a predicable, replaceable and organized tool.

It is considering to be used in industrial field having a greatest advantage of “no-over tighten”.

It prevents the damages of the screw and tool, in addition it provides a replaceable function to fit with driver bits having different shape and dimensions.

# Smart Torque Everywhere Possible

Adapter  
Custom  
Design

## Predictable

- When the demand torque is reached, there is a click sound. For continued tightening on the screw, it is no longer to increase the torque on the screw.
- It has a reversible system to use the same screwdriver for tightening and loosening the screw.
- The limit of loosening torque is larger than the tightening torque to protect both tool and the screw from the breaking or damage.
- Fasten or loosen the screws quickly.
- Torque tested to DIN EN ISO 6789.



## Replaceable

- Not only the bit, the torque adapter is also replaceable.
- Light and precise! Ideal as economic torque screwdriver.
- Fitting with a universal handle, the most compact size of torque screwdriver in the world is built.
- The cost of the torque adapter is lower in comparison with other brands.
- Different torque value preset adapter is available on request.
- Ergonomically refined design.
- Color recognition.

## Organized

- Persisting highest quality to supply SLOKY products and services to meet customer's satisfactions.
- Accomplishing customer's requirements by professional technology.

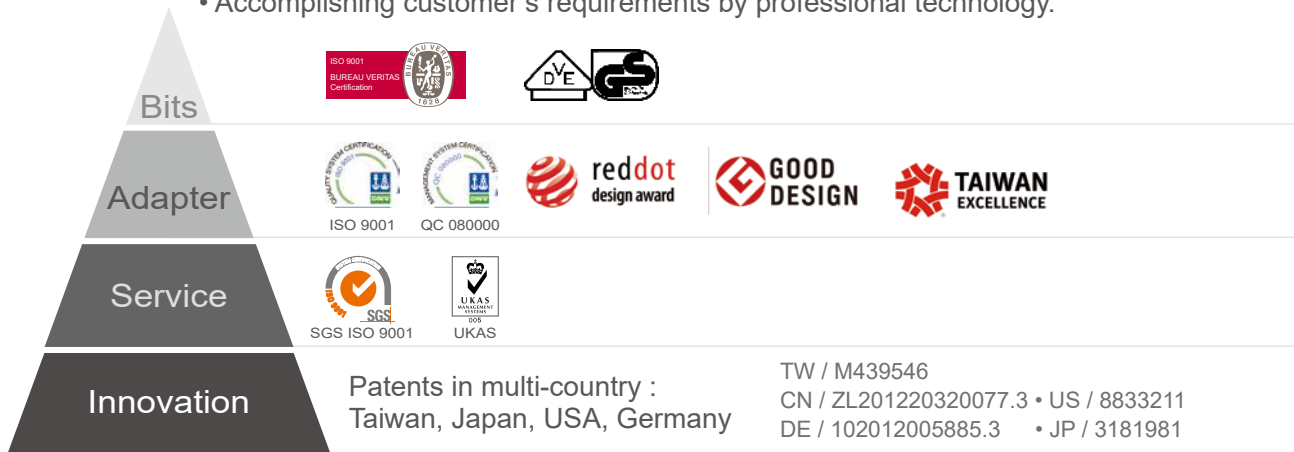



# Interchangeable system



Step 1  
Torque adapter

Identify the torque range you need to apply



Step 2  
Handle

Choose the most suitable handle



Step 3  
Bits

Select the bits that works best for you

Application Unlimited, Smart Torque Everywhere Possible.

One system with 3 Handles, 12 Torque, TX/IP/HEX, 25/50/75mm bits, 324 combos !!

Not only the bits and handle, the torque adapter is also interchangeable!



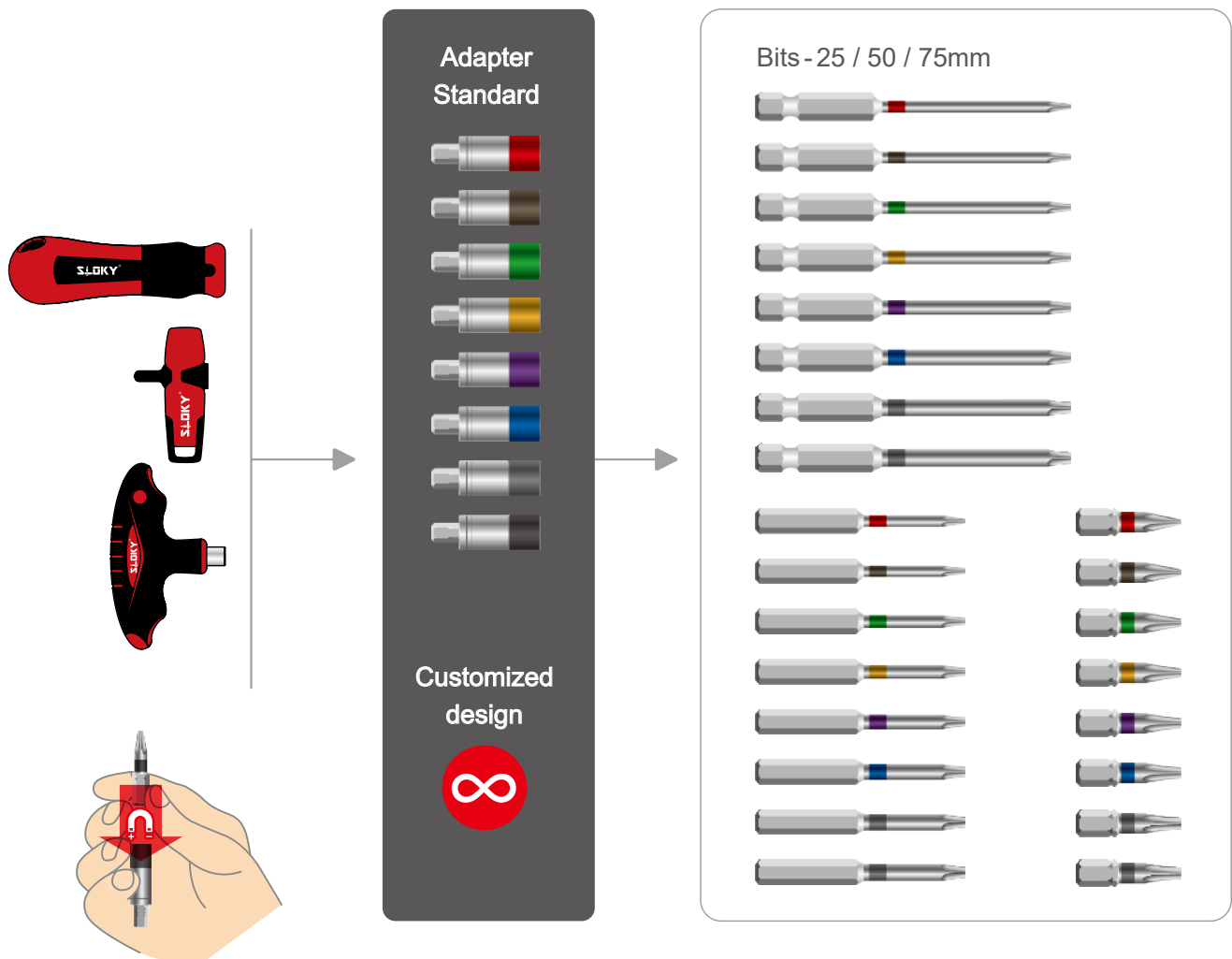



Specially compiled sets for every job, for Custom Design to meet your specific applications.







Simple operation All adapters with magnet, the bits can be inserted and automatically locked into the adapters.















# Contents

		Page
Adapters	 General Use Torque Adapter  0.6 ~ 5.7 Nm	08
	Small Torque Adapter 	08
	Extend Torque Adapter 	09
	Mini Torque Adapter 	10
	E6.3 Quick Change 	11
	5in1 Multi-Torque Adapter 	11
	Special Inquiry	12

Handle	 Universal Handle 	   	13
	Slim-Fit Handle 		
	T Flying Handle 		
	Mini Handle 		

Bits	 TORX® 	16
	TORX PLUS® 	17
	HEXAGON 	18

Kits		Pro Station 19 	Togo Kit 20 	Work Station 21 
				
		Single Set 22 	Single Set 22 	Smart Kit 22 
				

Info	 Accessory / User guide / Digital media	24
------	--	----

# Adapter

✓ According to  
DIN EN ISO 6789 life test

A "Click" sound when the  
demand torque is reached  
20,000 clicks guaranteed



Reversible system  
30% higher torque for loosening



## Principle

"No over tighten" adapter is created from the non-return ratchet torque socket.

It comprised a shaft rod and a shaft cylinder.

A core shaft of shaft rod is sleeved with a mobile ratchet capable of axially moving; the shaft cylinder has a shaft slot formed for being sleeved with the core shaft.

When the core shaft rotates in the shaft slot and the applied torque exceeds the preset torque value, the core shaft idly rotates in the shaft slot.

It means when the demand torque is reached, continued tightening is no longer to increase the torque on the screw.

- Different connecting and / or driving parts are available on request.
- Torque range is possible from 0.1Nm~18Nm.



Used Screwdriver  
Without Torque



Used Screwdriver  
With Torque



# General Use Torque Adapter

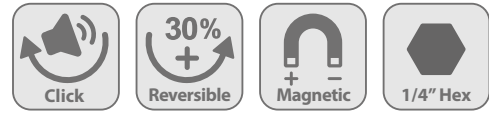

- Create your own set, general use for all kits.
- Special torque adapter or torque accuracy  $\pm 6\%$  are available on request. Please refer to P12.
- Torque Accuracy :  $\pm 10\%$

Parts No.	0-TPK12-EX
N.W.	370g
MOQ	3 kits

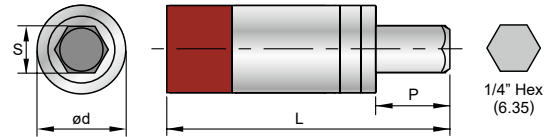

Adapter

## Torque Adapter (A) $\varnothing 12$ mm

- With \* mark is non-stock item. MOQ: 10 boxes.

Parts No.	Nm	KgfcM	In-lb	S (mm)	$\varnothing d$ (mm)	L (mm)	P (mm)	Q'TY	N.W.	Packaging Illustration
0-TPK-A06-0.6	0.6	6.1	5.3	DIN 3126 1/4" Hex (6.35mm)	12	38.3	10	3 pcs	80g	
0-TPK-A07-0.9	0.9	9.2	8.0							
0-TPK-A08-1.2	1.2	12.0	10.6							
0-TPK-A08-2.0	2.0	20.4	17.7							
0-TPK-A09-1.4	1.4	14.0	12.4							
0-TPK-A09-2.0	2.0	20.4	17.7							
0-TPK-A10-2.0	2.0	20.4	17.7							
0-TPK-A15-3.0	3.0	30.6	26.6							
0-TPK-A20-5.0	5.0	51.0	44.3							
0-TPK-A20-5.5	5.5	56.1	48.7							
0-TPK-A25-5.5	5.5	56.1	48.7	DIN 3126 1/4" Hex (6.35mm)	12	38.3	10	3 pcs	80g	
* 0-TPK-A00-1.0	1.0	10.2	8.8							
* 0-TPK-A00-1.5	1.5	15.3	13.3							
* 0-TPK-A00-2.2	2.2	22.4	19.5							
0-TPK-A00-2.5	2.5	25.5	22.1							
* 0-TPK-A00-3.5	3.5	35.7	31.0							
0-TPK-A00-3.8	3.8	38.7	33.6							
0-TPK-A00-4.0	4.0	40.8	35.4							
0-TPK-A00-4.5	4.5	45.9	39.8							
0-TPK-A00-5.7	5.7	58.0	50.4							

## Small Torque Adapter

### (STA) $\varnothing 10$ mm

- With \* mark is non-stock item. MOQ: 10 boxes.

Parts No.	Nm	KgfcM	In-lb	S (mm)	$\varnothing d$ (mm)	L (mm)	P (mm)	Q'TY	N.W.	Packaging Illustration
* 0-TPK-STA-0.1	0.1	1.0	0.9	DIN 3126 1/4" Hex (6.35mm)	10	34.5	10	3 pcs	60g	
0-TPK-STA-0.2	0.2	2.0	1.8							
0-TPK-STA-0.3	0.3	3.1	2.7							
0-TPK-STA-0.4	0.4	4.1	3.5							
0-TPK-STA-0.5	0.5	5.1	4.4							
* 0-TPK-STA-0.6	0.6	6.1	5.3							
* 0-TPK-STA-0.7	0.7	7.1	6.2							

# Extend Torque Adapter

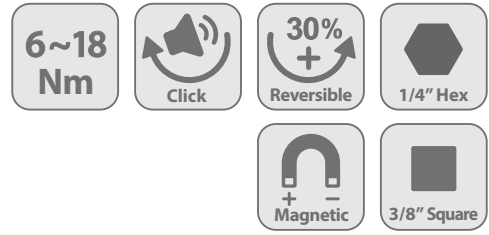

- Torque range : 6-18Nm
- Various types of connecting and driving design.
- With \* mark is non-stock item. MOQ: 30 pcs.
- Torque Accuracy :  $\pm 10\%$

## ETA

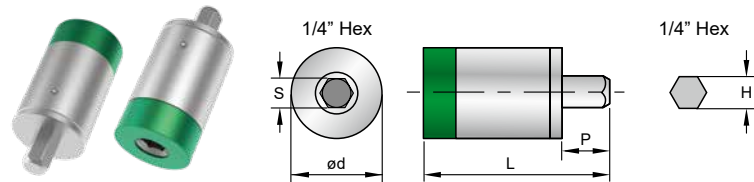

Parts No.	Nm	Kgfc <sub>m</sub>	In-lb	Driving S (mm)	Ød (mm)	L (mm)	P (mm)	Connecting H (mm)	Q'TY	N.W.
0-TPK-ETA-6.0	6.0	61.1	53.1	DIN 3126 1/4" Hex	20	43.5	10	DIN 3126 1/4" Hex	1 pc	80g
* 0-TPK-ETA-6.5	6.5	66.2	57.5							
* 0-TPK-ETA-7.0	7.0	71.3	62.0							
0-TPK-ETA-8.0	8.0	81.5	70.8							
0-TPK-ETA-10.0	10.0	101.9	88.5							

## ETB

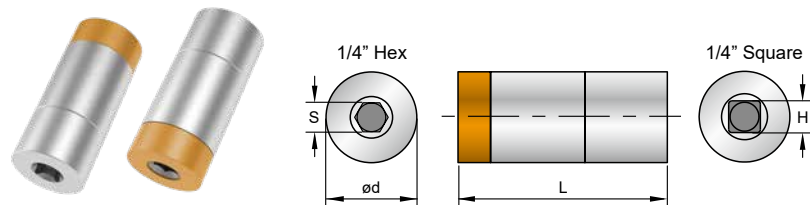

Parts No.	Nm	Kgfc <sub>m</sub>	In-lb	Driving S (mm)	Ød (mm)	L (mm)	P (mm)	Connecting H (mm)	Q'TY	N.W.
0-TPK-ETB-8.0	8.0	81.5	70.8	DIN 3126 1/4" Hex	20	44.5	--	DIN 3120 1/4" Square	1 pc	100g
0-TPK-ETB-10.0	10.0	101.9	88.5							
0-TPK-ETB-12.0	12.0	122.3	106.2							
* 0-TPK-ETB-15.0	15.0	152.9	132.8							
* 0-TPK-ETB-18.0	18.0	183.4	159.3							

## ETC

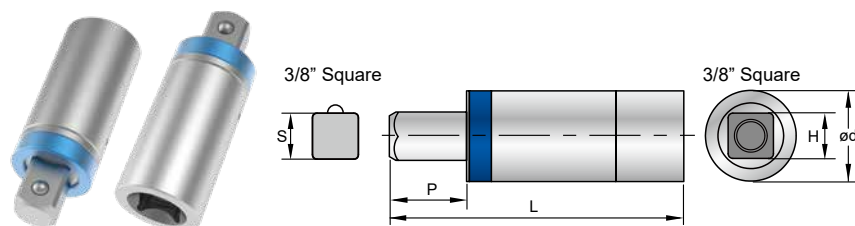

Parts No.	Nm	Kgfc <sub>m</sub>	In-lb	Driving S (mm)	Ød (mm)	L (mm)	P (mm)	Connecting H (mm)	Q'TY	N.W.
0-TPK-ETC-8.0	8.0	81.5	70.8	DIN 3122/ DIN 3123 3/8" Square	20	53.0	12	DIN 3120 3/8" Square	1 pc	90g
0-TPK-ETC-10.0	10.0	101.9	88.5							
0-TPK-ETC-12.0	12.0	122.3	106.2							
* 0-TPK-ETC-15.0	15.0	152.9	132.8							
* 0-TPK-ETC-18.0	18.0	183.4	159.3							

# Mini Torque Adapter



- Torque range : 10-70cNm
- Adapter diameter is only 8mm.
- Torque Accuracy : ±10%

## A total solution for applications below

- Fine Cutting Tool
- Communication Devices
- Consumer Electronics
- Drones/UAV
- Smart Phones
- Printed Circuit Boards
- Watches .....

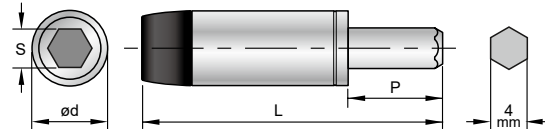

Parts No.	cNm	KgfcM	In-lb	S (mm)	Ød (mm)	L (mm)	P (mm)	Q'TY	N.W.	Packaging Illustration
0-TPK-MTA-0.1	10	1.0	0.9	4mm Hex	8	32	10	3 pcs	35g	
0-TPK-MTA-0.2	20	2.0	1.8							
0-TPK-MTA-0.3	30	3.1	2.7							
0-TPK-MTA-0.4	40	4.1	3.5							
0-TPK-MTA-0.5	50	5.1	4.4							
0-TPK-MTA-0.6	60	6.1	5.3							
0-TPK-MTA-0.7	70	7.1	6.2							

## Mini Torque Adapter Kit

Parts No.	0-TPK-MTA-DEMO
N.W.	200g
MOQ	3 kits



## Transform normal screwdriver to torque screwdriver

- SLOKY mini torque adapter fits almost any kinds of the 4mm bits and handle with Ø4 mm in the market.

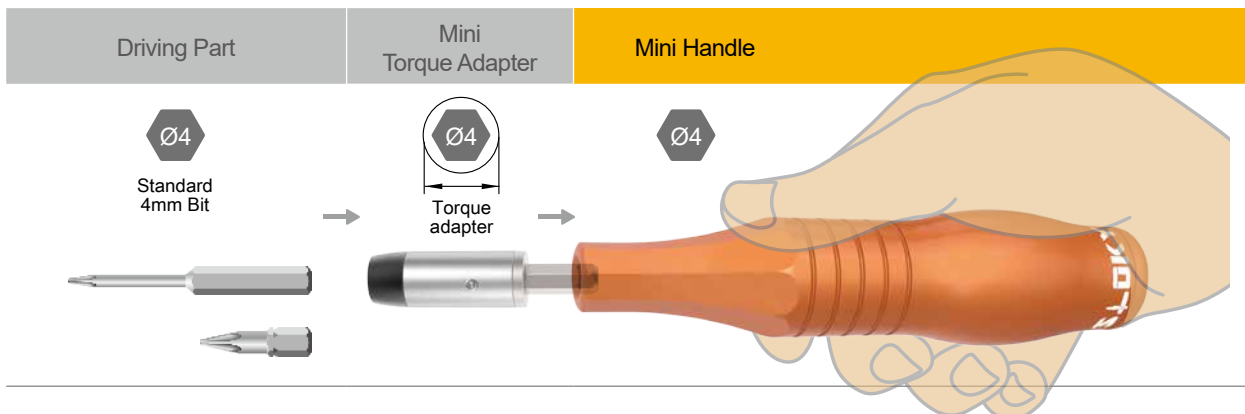

Mini Torque Adapter

# E6.3 Quick Change Torque Adapter

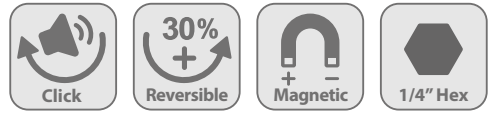

## E6.3 Torque Adapter (PTEQ)

- With quick change design.
- Speed limits below 250 r.p.m.
- Further tightening by hand to reach required torque.
- Shorten tightening job for long screws or very many screws, and identical torque controlled.
- Torque Accuracy :  $\pm 10\%$

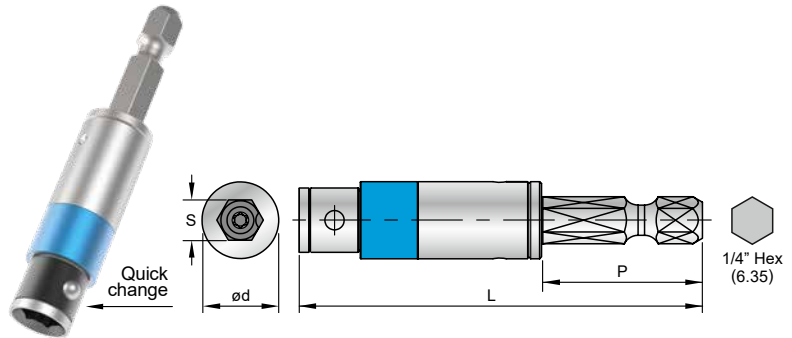

Parts No.	Nm	KgfcM	In-lb	S (mm)	Ød (mm)	L (mm)	P (mm)	Q'TY	N.W.
0-TPK-PTEQ-6.3-2.0	2.0	20.4	17.7	DIN 3126 1/4" Hex	12	62.7	25	1 pc	35g
0-TPK-PTEQ-6.3-3.0	3.0	30.6	26.6						
0-TPK-PTEQ-6.3-4.5	4.5	45.9	39.8						
0-TPK-PTEQ-6.3-5.0	5.0	51.0	44.3						

# 5in1 Multi-Torque Adapter



## 2, 3, 4, 5, 6Nm

- Visually define torque value on adapter.
- Universal type, 5 in 1 torque control from 2Nm to 6Nm.
- No more over or under tightening on your screw.
- Easy to use for multiple torque requirements.
- Not for loosening.

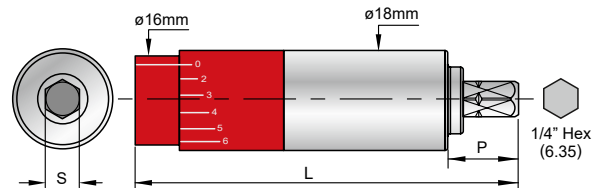

Parts No.	Nm	KgfcM	In-lb	S (mm)	Ød (mm)	L (mm)	P (mm)	Q'TY	N.W.
0-TPK-5IN1-6.0	2.0	20.4	17.7	DIN 3126 1/4" Hex	18	68.8	10	1 pc	105g
	3.0	30.6	26.6						
	4.0	40.8	35.4						
	5.0	51.0	44.3						
	6.0	61.1	53.1						

\* Other torque range is available on request, max. torque 10Nm.

## 5in1 Multi Torque Adapter Kit

Parts No.	0-TPK-5IN1-H03
N.W.	220g



- Before use, confirm tool is at the "0" setting.
- Turn the handle clockwise, until the required torque is aligned with datum line.





# Special Inquiry

Please send your inquiry to [sloky@jimmore.com.tw](mailto:sloky@jimmore.com.tw)

## ► Company

## ► Phone / Email

Adapter

Adapter Diameter	ØD mm	
	Torque Range	Fig
Ø 8mm Ø10mm	0.1 ~ 0.7 Nm	<b>1</b> , <b>2</b>
Ø12mm	0.6 ~ 6.0 Nm	<b>3</b> , <b>4</b>
Ø20mm	6.0 ~ 18.0 Nm	<b>5</b> , <b>6</b> , <b>7</b>
Specification (Fig)	<input type="checkbox"/> 1 <input type="checkbox"/> 2 <input type="checkbox"/> 3 <input type="checkbox"/> 4 <input type="checkbox"/> 5 <input type="checkbox"/> 6 <input type="checkbox"/> 7	
Required Torque	Nm	
Torque Tolerance	<input type="checkbox"/> ±6% <input type="checkbox"/> ±10%	
L Overall Length	mm	
Connecting Part		
DIN ISO Standard		
Type	<input type="checkbox"/> C type  <input type="checkbox"/> E type  <input type="checkbox"/> Other	
H (Connecting Head)	<input type="checkbox"/> Male <input type="checkbox"/> Female <input type="checkbox"/> Hex <input type="checkbox"/> Square	
Size	_____ mm/inch E.g. 1/4", 3/8", 1/2".....	
P (Connecting Length)	mm	
Driving Part		
DIN ISO Standard		
S (Driving Head)	<input type="checkbox"/> Male <input type="checkbox"/> Female <input type="checkbox"/> Hex <input type="checkbox"/> Square	
Depth Overall Length	mm	
Size	_____ mm/inch E.g. 1/4", 3/8", 1/2".....	
Quick Change	<input type="checkbox"/> Yes <input type="checkbox"/> No	

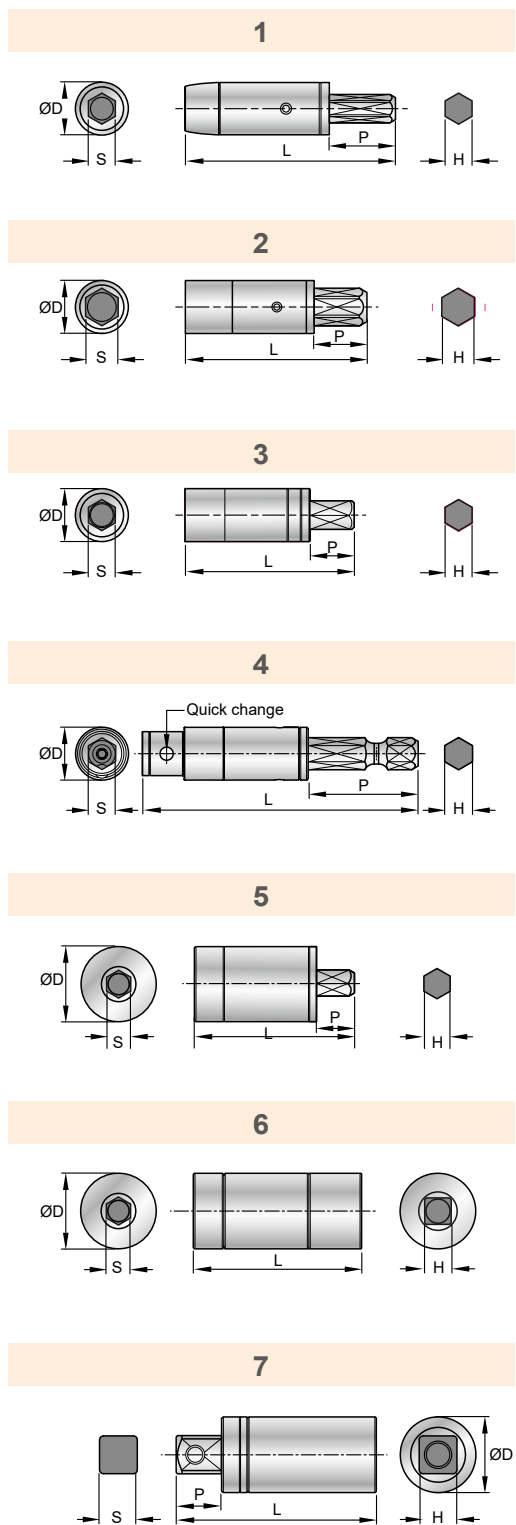

# Handle



✓ The ergonomic design of the handle

## Features

We offer 4 different types of handle to cover all torque adapters. The soft zone is comfortable to hold and play very flexible. Easy to tighten and loosen screws even in higher torque range. The outstanding design of the SLOKY handle that fits perfectly into the hand and prevents the hand injuries such as blisters and calluses.

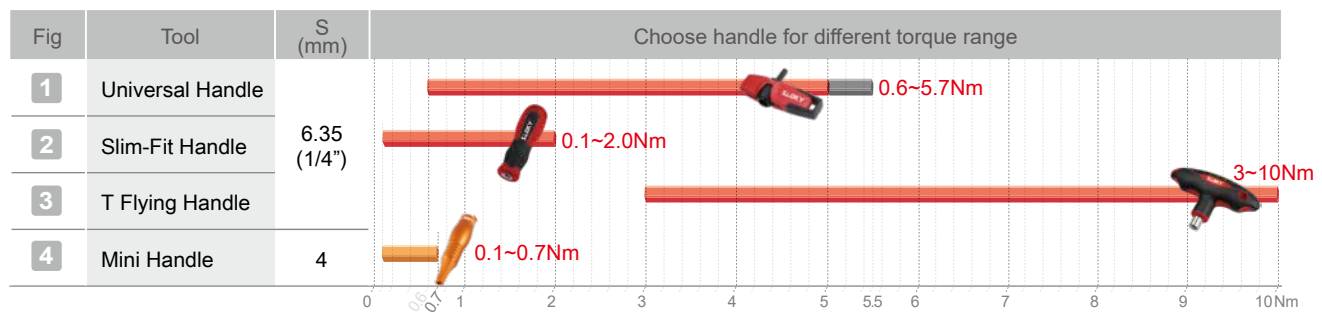



## Universal Handle

### Features

- Universal type for holding in multi-ways.
- Having large support surfaces for thumb and index finger ease of use and efficiency.
- Remaining the advantages of flag design, driving the screw easily.

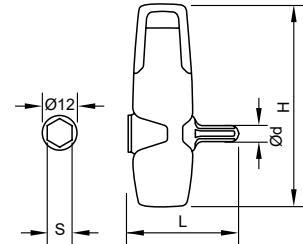

Fig	Parts No.	Suit For Torque	Color	S (mm)	L (mm)	H (mm)	Ød (mm)	N.W.
1	0-TPK-H01	0.6~5.7 Nm	Red	6.35 (1/4")	37.5	70.7	5	25g
	0-TPK-H01-B		Blue					

## Slim-Fit Handle

### Features

- Comfortable holding, for accurate and efficient while fastening and loosening small size screws.

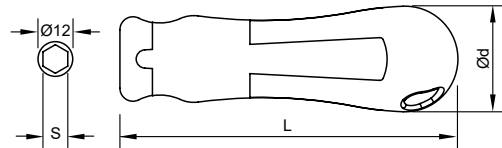

Fig	Parts No.	Suit For Torque	Color	S (mm)	L (mm)	Ød (mm)	N.W.
2	0-TPK-H02	0.1~2.0 Nm	Red	6.35 (1/4")	104	32.5	50g
	0-TPK-H02-B		Blue				

## T Flying Handle

### Features

- It is light, even it is designed for higher torque.
- The striking soft zone that allows particularly comfortable, best handle for using at higher torque.

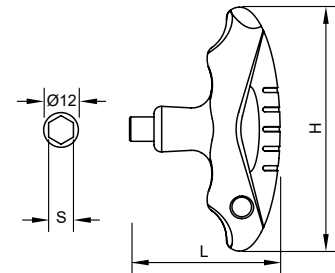

Fig	Parts No.	Suit For Torque	Color	S (mm)	L (mm)	H (mm)	N.W.
3	0-TPK-H03	3.0~10.0 Nm	Red	6.35 (1/4")	65	100	60g
	0-TPK-H03-B		Blue				

## Mini Handle

### Features

- Aluminum Alloy made.

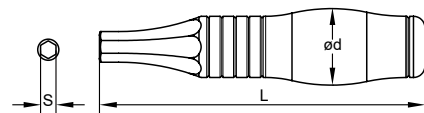

Fig	Parts No.	Suit For Torque	Color	S (mm)	L (mm)	Ød (mm)	N.W.
4	0-TPK-H05	10~70 cNm (0.1~0.7 Nm)	Orange	4	85	20	70g

# Bits



TORX®



TORX PLUS®



HEXAGON

✓ Tools created from ideas



## Color Identity

No mistake!

The color identification is visible on both adapters and bits.

Select suitable torque size by color management system indicated on torque adapters and bits.

It is to enhance the convenience of using and delivery proper tightening torque.



Rapid-out  
Simply pull the bit outward to change new bit



# Spare-TORX®

Hardness : HRC 58° ~ 60°  
Material : High alloy steel

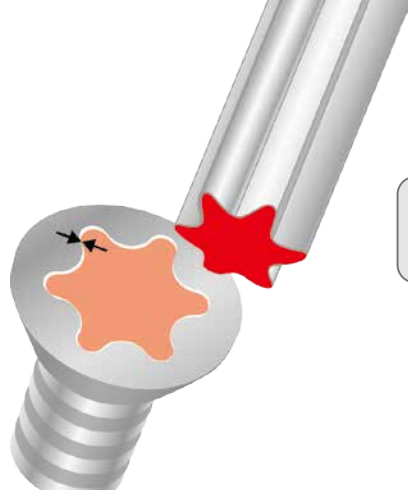

TORX®

## 25mm Bits for TORX® screws

Standard : DIN3126 – C6.3 (1/4")

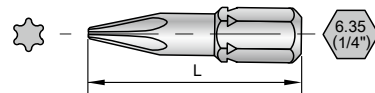

Parts No.	Driver Size	L (mm)	Q'TY	N.W.	Packaging Illustration
0-TPK-B01-TX06-25	TX6	25	6 pcs	32 g	
0-TPK-B01-TX07-25	TX7			32 g	
0-TPK-B01-TX08-25	TX8			32 g	
0-TPK-B01-TX09-25	TX9			32 g	
0-TPK-B01-TX10-25	TX10			32 g	
0-TPK-B01-TX15-25	TX15			34 g	
0-TPK-B01-TX20-25	TX20			34 g	

## 50mm Bits for TORX® screws

Standard : DIN3126 – C6.3 (1/4")

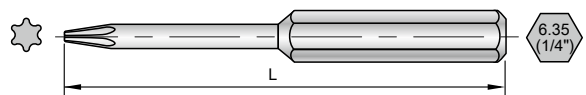

Parts No.	Driver Size	L (mm)	Q'TY	N.W.	Packaging Illustration
0-TPK-B01-TX06-50	TX6	50	6 pcs	54 g	
0-TPK-B01-TX07-50	TX7			54 g	
0-TPK-B01-TX08-50	TX8			54 g	
0-TPK-B01-TX09-50	TX9			56 g	
0-TPK-B01-TX10-50	TX10			58 g	
0-TPK-B01-TX15-50	TX15			60 g	
0-TPK-B01-TX20-50	TX20			62 g	
0-TPK-B01-TX25-50	TX25	62 g			

## 75mm Bits for TORX® screws

Standard : DIN3126 – E6.3 (1/4")

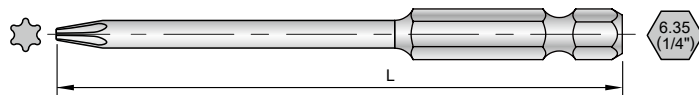

Parts No.	Driver Size	L (mm)	Q'TY	N.W.	Packaging Illustration
0-TPK-B01-TX08-75	TX8	75	6 pcs	58 g	
0-TPK-B01-TX09-75	TX9			64 g	
0-TPK-B01-TX10-75	TX10			70 g	
0-TPK-B01-TX15-75	TX15			70 g	
0-TPK-B01-TX20-75	TX20			78 g	
0-TPK-B01-TX25-75	TX25			88 g	

TORX® and TORX PLUS® are registered trademarks of Acument Global Technologies.

# Spare-TORX PLUS®

Hardness : HRC 58° ~ 60°  
Material : High alloy steel

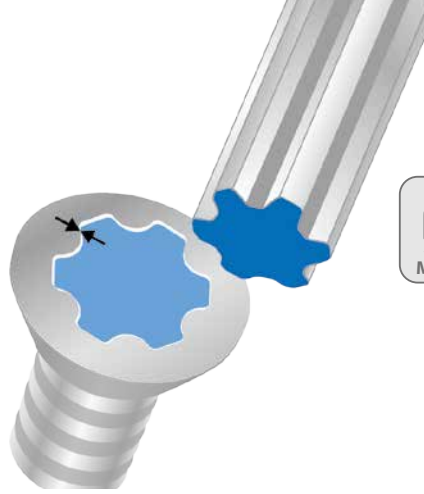

## 25mm Bits for TORX PLUS® screws

Standard : DIN3126 – C6.3 (1/4")

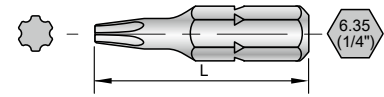

Parts No.	Driver Size	L (mm)	Q'TY	N.W.	Packaging Illustration
0-TPK-B02- 6IP-25	6IP	25	6 pcs	32 g	
0-TPK-B02- 7IP-25	7IP			32 g	
0-TPK-B02- 8IP-25	8IP			32 g	
0-TPK-B02- 9IP-25	9IP			32 g	
0-TPK-B02-10IP-25	10IP			32 g	
0-TPK-B02-15IP-25	15IP			34 g	
0-TPK-B02-20IP-25	20IP			34 g	

## 50mm Bits for TORX PLUS® screws

Standard : DIN3126 – C6.3 (1/4")

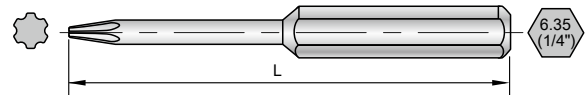

Parts No.	Driver Size	L (mm)	Q'TY	N.W.	Packaging Illustration
0-TPK-B02- 6IP-50	6IP	50	6 pcs	54 g	
0-TPK-B02- 7IP-50	7IP			54 g	
0-TPK-B02- 8IP-50	8IP			54 g	
0-TPK-B02- 9IP-50	9IP			56 g	
0-TPK-B02-10IP-50	10IP			58 g	
0-TPK-B02-15IP-50	15IP			60 g	
0-TPK-B02-20IP-50	20IP			62 g	
0-TPK-B02-25IP-50	25IP	66 g			

## 75mm Bits for TORX PLUS® screws

Standard : DIN3126 – E6.3 (1/4")

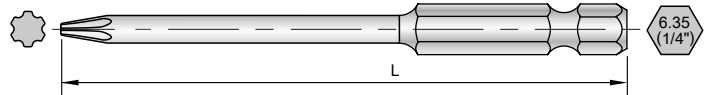

Parts No.	Driver Size	L (mm)	Q'TY	N.W.	Packaging Illustration
0-TPK-B02- 8IP-75	8IP	75	6 pcs	64 g	
0-TPK-B02- 9IP-75	9IP			66 g	
0-TPK-B02-10IP-75	10IP			72 g	
0-TPK-B02-15IP-75	15IP			72 g	
0-TPK-B02-20IP-75	20IP			78 g	
0-TPK-B02-25IP-75	25IP			86 g	

TORX® and TORX PLUS® are registered trademarks of Acument Global Technologies.

# Spare - HEXAGON

Hardness : HRC 58° ~ 60°  
Material : High alloy steel

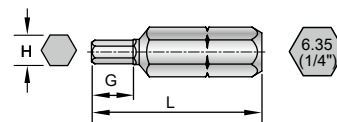
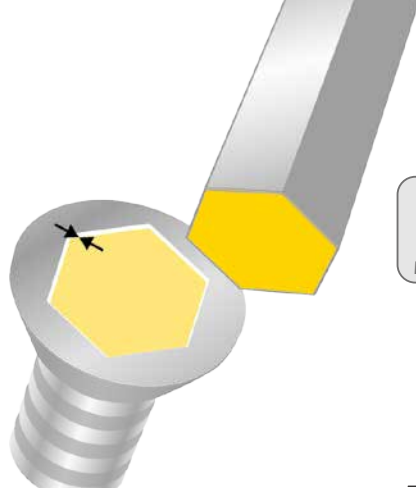

HEXAGON

## 25mm Bits for HEXAGON screws

Standard : DIN3126 – C6.3 (1/4")

Parts No.	Driver Size	H (mm)	G (mm)	L (mm)	Q'TY	N.W.	Packaging Illustration
0-TPK-B03-H015-25	H1.5	1.5	2.3			32 g	
0-TPK-B03-H020-25	H2	2.0	3.0			32 g	
0-TPK-B03-H025-25	H2.5	2.5	3.8		25 6 pcs	33 g	
0-TPK-B03-H030-25	H3	3.0	4.5			34 g	
0-TPK-B03-H040-25	H4	4.0	6.0			36 g	
0-TPK-B03-H050-25	H5	5.0	7.5			40 g	

## 50mm Bits for HEXAGON screws

Standard : DIN3126 – E6.3 (1/4")

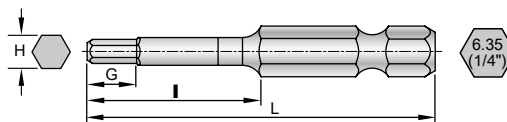

Parts No.	Driver Size	H (mm)	G (mm)	I (mm)	L (mm)	Q'TY	N.W.	Packaging Illustration
0-TPK-B03-H015-50	H1.5	1.5	2.3				50 g	
0-TPK-B03-H020-50	H2	2.0	3.0				51 g	
0-TPK-B03-H025-50	H2.5	2.5	3.8			25 50 6 pcs	54 g	
0-TPK-B03-H030-50	H3	3.0	4.5				57 g	
0-TPK-B03-H040-50	H4	4.0	6.0				64 g	
0-TPK-B03-H050-50	H5	5.0	7.5				72 g	

# Pro Station



All-in-One **TORX® TORX PLUS® HEXAGON** tools for professional using

- Easy to store and pick up
- Cover popular torque from 0.6Nm to 5.5Nm
- A perfect tool set for every station of production line.



Parts No.	0-TPK26-PR-22K
N.W.	1,600g

Handle	Contents									
	Adapter				★ 50mm		⚙ 50mm		⬡ 50mm	
	Nm	KgfcM	In-lb	Q'TY	Size	Q'TY	Size	Q'TY	Size	Q'TY
 TPK-H02-B	0.6	6.1	5.3	1 pc	TX6	1 pc	6IP	1 pc	H1.5	1 pc
	0.9	9.2	8.0		TX7		7IP		-	-
	1.2	12.0	10.6		TX8		8IP		H2	1 pc
 TPK-H01-B	1.4	14.0	12.4		TX9		9IP		-	-
	2.0	20.4	17.7		TX10		10IP		H2.5	1 pc
 TPK-H03-B	3.0	30.6	26.6		TX15		15IP		H3	
	5.0	51.0	44.3		TX20		20IP		H4	
	5.5	56.1	48.7		TX25		25IP		H5	

## Tool stand

- Good for storage and workbench.
- Tool stand is made of aluminum alloy, silver coating.

Parts No.	0-TPK26-PR
N.W.	1,000g
Dimension	W170 x D120 x H30mm



# Togo Kit

Collecting the most popular torque tools  
Ready to go.



Togo Kit

## Torque Screwdriver Kit for TORX®, 25mm+50mm Bits

Parts No.	Contents						N.W.	Packaging Illustration
	Handle	Adapter				Bit 25mm+50mm		
		Size	Nm	KgfcM	In-lb			
0-TPK01-TGTX-12K	TPK-H02	TX6	0.6	6.1	5.3	1 pc + 1 pc	445g	
		TX7	0.9	9.2	8.0			
		TX8	1.2	12.0	10.6			
	TPK-H01	TX9	1.4	14.0	12.4			
		TX10	2.0	20.4	17.7			
		TX15	3.0	30.6	26.6			

## Torque Screwdriver Kit for TORX PLUS®, 25mm+50mm Bits

Parts No.	Contents						N.W.	Packaging Illustration
	Handle	Adapter				Bit 25mm+50mm		
		Size	Nm	KgfcM	In-lb			
0-TPK02-TGIP-12K	TPK-H02-B	6IP	0.6	6.1	5.3	1 pc + 1 pc	445g	
		7IP	0.9	9.2	8.0			
		8IP	1.2	12.0	10.6			
	TPK-H01-B	9IP	1.4	14.0	12.4			
		10IP	2.0	20.4	17.7			
		15IP	3.0	30.6	26.6			

## Torque Screwdriver Kit for HEXAGON, 25mm+50mm Bits

Parts No.	Contents						N.W.	Packaging Illustration
	Handle	Adapter				Bit 25mm + 50mm		
		Size	Nm	KgfcM	In-lb			
0-TPK03-TGHX-12K	TPK-H02	H1.5	0.6	6.1	5.3	1 pc + 1 pc	445g	
		H2.0	1.2	12.0	10.6			
		H2.5	2.0	20.4	17.7			
	TPK-H01	H3.0	3.0	30.6	26.6			
		H4.0	5.0	51.0	44.3			
		H5.0	5.5	56.1	48.7			

TORX® and TORX PLUS® are registered trademarks of Acument Global Technologies.

# Work Station

For your long time using and storage.

## Torque Screwdriver Kit for TORX®, 25mm+50mm Bits

Parts No.	Contents						N.W.	Packaging Illustration
	Handle	Adapter				Bit 25mm+50mm		
		Size	Nm	KgfcM	In-lb			
0-TPK01-PR-12	TPK-H02	TX6	0.6	6.1	5.3	1 pc + 1 pc	855g	
		TX7	0.9	9.2	8.0			
		TX8	1.2	12.0	10.6			
	TPK-H01	TX9	1.4	14.0	12.4			
		TX10	2.0	20.4	17.7			
		TX15	3.0	30.6	26.6			

## Torque Screwdriver Kit for TORX PLUS®, 25mm+50mm Bits

Parts No.	Contents						N.W.	Packaging Illustration
	Handle	Adapter				Bit 25mm+50mm		
		Size	Nm	KgfcM	In-lb			
0-TPK02-PR-12	TPK-H02-B	6IP	0.6	6.1	5.3	1 pc + 1 pc	855g	
		7IP	0.9	9.2	8.0			
		8IP	1.2	12.0	10.6			
	TPK-H01-B	9IP	1.4	14.0	12.4			
		10IP	2.0	20.4	17.7			
		15IP	3.0	30.6	26.6			

## Torque Screwdriver Kit for HEXAGON, 25mm+50mm Bits

Parts No.	Contents						N.W.	Packaging Illustration
	Handle	Adapter				Bit 25mm + 50mm		
		Size	Nm	KgfcM	In-lb			
0-TPK03-PR-12	TPK-H02	H1.5	0.6	6.1	5.30	1 pc + 1 pc	855g	
		H2.0	1.2	12.0	10.6			
		H2.5	2.0	20.4	17.7			
	TPK-H01	H3.0	3.0	30.6	26.6			
		H4.0	5.0	51.0	44.3			
		H5.0	5.5	56.1	48.7			

TORX® and TORX PLUS® are registered trademarks of Acument Global Technologies.

# Smart Kit

Cover 0.6Nm to 5.5Nm adapters with one universal handle.

## Torque Screwdriver Kit for TORX®, 25mm Bits

Parts No.	Contents						N.W.	Metric Screw	Packaging Illustration
	Handle	Adapter			Bit				
		Size	Nm	KgfcM	In-lb	25mm			
0-TPK01-99-06K	TPK-H01	TX6	0.6	6.1	5.3	1 pc	290g	M1.8 M2	
		TX7	0.9	9.2	8.0			M2 M2.2	
		TX8	1.2	12.0	10.6			M2.2 M2.5	
		TX9	2.0	20.4	17.7			M3 M3.5	
		TX15	3.0	30.6	26.6			M3.5 M4	
		TX20	5.5	56.1	48.7			M5 M5.5	

\* Smart Kit for TORX PLUS® is available on request, Part No. 0-TPK02-99-06K.

# Single Set | Economical Starter

## Torque Screwdriver Single Set for TORX®, 25mm+50mm Bits

Parts No.	Contents						N.W.	Packaging Illustration	
	Handle	Adapter			Bit				
		Nm	KgfcM	In-lb	Size	25mm+50mm			
0-TPK01-TX06-0.6-S	TPK-H02	0.6	6.1	5.3	TX6	2 pcs + 2 pcs	122g		
0-TPK01-TX07-0.9-S		0.9	9.2	8.0	TX7				
0-TPK01-TX08-1.2-S		1.2	12.0	10.6	TX8				
0-TPK01-TX08-2.0	TPK-H01	2.0	20.4	17.7	TX8	2 pcs + 2 pcs	130g		
0-TPK01-TX09-1.4		1.4	14.0	12.4	TX9				
0-TPK01-TX09-2.0		2.0	20.4	17.7					
0-TPK01-TX10-2.0		2.0	20.4	17.7	TX10				
0-TPK01-TX15-3.0		3.0	30.6	26.6	TX15				
0-TPK01-TX20-5.0		5.0	51.0	44.3	TX20				
0-TPK01-TX20-5.5	5.5	56.1	48.7	TX20	Bit 50mm	200g			
0-TPK01-TX2025-5.5	TPK-H03	5.5	56.1	48.7				TX20	2 pcs
								TX25	2 pcs



TORX® and TORX PLUS® are registered trademarks of Acument Global Technologies.

Smart Kit



# Single Set | Economical Starter

Single Set

## Torque Screwdriver Single Set for TORX PLUS®, 25mm+50mm Bits

Parts No.	Contents						N.W.	Packaging Illustration	
	Handle	Adapter			Bit				
		Nm	KgfcM	In-lb	Size	25mm+50mm			
0-TPK02- 6IP-0.6-S	TPK-H02-B	0.6	6.1	5.3	6IP	2 pcs + 2 pcs	130g		
0-TPK02- 7IP-0.9-S		0.9	9.2	8.0	7IP				
0-TPK02- 8IP-1.2-S		1.2	12.0	10.6	8IP				
0-TPK02- 9IP-1.4	TPK-H01-B	1.4	14.0	12.4	9IP	2 pcs + 2 pcs	130g		
0-TPK02-10IP-2.0		2.0	20.4	17.7	10IP				
0-TPK02-15IP-3.0		3.0	30.6	26.6	15IP				
0-TPK02-20IP-5.0	TPK-H03-B	5.0	51.0	44.3	20IP	2 pcs	200g		
0-TPK02-2025IP-5.5									Bit 50mm
									25IP

## Torque Screwdriver Single Set for HEXAGON, 25mm+50mm Bits

Parts No.	Contents						N.W.	Packaging Illustration
	Handle	Adapter			Bit			
		Nm	KgfcM	In-lb	Size	25mm+50mm		
0-TPK03-H020-1.2	TPK-H02	1.2	12.0	10.6	H2	2 pcs + 2 pcs	150g	
0-TPK03-H025-2.0	TPK-H01	2.0	20.4	17.7	H2.5	2 pcs + 2 pcs	135g	
0-TPK03-H030-3.0		3.0	30.6	26.6	H3			
0-TPK03-H040-5.0	TPK-H03	5.0	51.0	44.3	H4	4 pcs	200g	

TORX® and TORX PLUS® are registered trademarks of Acument Global Technologies.



# Accessory

Accessories that are compatible with SLOKY torque screwdrivers.

## Torque Analyzer

- Made in Japan

Parts No.	08-CD-100M
N.W.	1,000g
Dimension	W160 × D125 × H55mm



Model No.		CD-100M
Measuring Range	Nm	0.10~10.00
	kgf-cm	1.0~100.0
	lbf-in	1.0~90.0
Accuracy		±0.5% (199 or less digit ± 1 digit)
Display		The 3.5 figures digital display of LCD
Measurement Mode	P-P	The maximum under measurement is always displayed.
	T-R	The value of the load torque concerning a detector is displayed as it is.
	P-D	A value when a load torque value changes from a rise to descent is displayed.
Transmission interface		USB (Baud rate : 19200)
Auto Power Off		Power-supply OFF is carried out after the neglect during 10 minutes.
Battery		Ni-cd battery : 1.2V/5sells (700mAh)
Charge time / Use time		About 3 hours / About 12 hours use consecutive at full charge time
Measurement Joint	Spec.	SJ-50
	Measurement Range	0.5~5 Nm

## 3 Seats Magnet Tool Stand

- Quick and fix on anywhere with metal surface.
- Acrylic material with magnet support up to 1kg.
- All SLOKY screwdrivers can be fit with.

Parts No.	0-TPK-03S
N.W.	100g
Dimension	W110 x D55 x H50mm

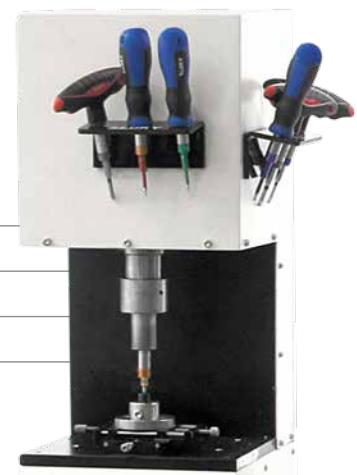

★ Not include torque screwdriver

# User Guide

Why the torque may get low after using a certain time?

The torque adapter is functional by the radial direction friction. It is different from the marketed product nowadays. When an object slips or is going to slip with another object, on the two contact faces will create a relative action. This relative action is called the static friction. It creates the abrasion after using a certain time. Thus, the preset torque adapter may get low due to this abrasion.

How to judge?

- $\pm 10\%$  allowance for torque adapter is acceptable.
- Please check it on torque analyzer or measurement.

 Warning

**Tightened screws with unknown torque**



Do not use Sloky torque screwdriver to loosen tightened screws with unknown torque.

## The tips of using different handle

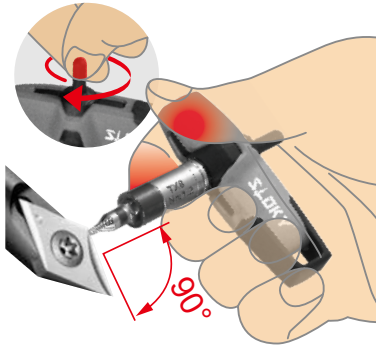

Large support areas for thumb and index finger on the ergonomically shaped handles.

The transmission of high torque is thus quite simple. Cylindrical handle shaft for quick turning of screws.



Please be mind that bit and screw head must be angled 90 degree.



The Slim Fit handle has been designed to fit snugly in your hand, making blisters and calluses a thing of the past, even after intensive use.

The handle hard zones allows the hand to easily glide during hand repositioning.

The soft zones ensures full force transfer through the grip.



The T Flying handle is needed whenever particularly high torque for loosening or tightening jobs needs to be applied.

The power is transferred positively, there is no frictional loss between the hand and the handle.

## Digital Media

Youtube



Linkedin



Product Introduction



Catalog



Custom Design  
Medical & Public Safety Application  
Construction Application  
Industrial Application  
Leisure Application



**SLOKY**<sup>®</sup>  
**Smart Torque**  
**Everywhere**  
**Possible**



Where there is **SLOKY<sup>®</sup>**,  
there is quality.

